



Improving stone

SPECIALISTS IN LIMESTONE
SPÉCIALISTES EN PIERRE CALCAIRE

- Stone masonry
Projets en pierre naturelle

- Special pieces
Pièces spéciales

- Cut to size
Sur mesure

- Façades
Bardages

- Flooring
Sols

- Wall cladding
Revêtements de murs

- Decorative panels
Panneaux décoratifs

- Cantilevered stairs
Escaliers en colimaçon

- Fireplaces
Cheminées

- Bathrooms
Salles de bain

- Cornices
Corniches

- Balustrades
Balustrades

- SEMI-RIJO LR

- MOLEANOS LR

- MOLEANOS RIJO

- MOCA CREME

- MIRABELLE

- BRANCO DO MAR

- CABEÇA VEADA

- ROSAL

- BLUE SKY

- ATAIJA AZUL

- MOLEANOS AZUL

- RUIVINA

- ESTREMOZ

- ARDOISE/ SLATE

- Complete process: from **design** to **delivery**
*Gestion complète: du **dessin** à la **livraison***

- High-qualified technicians and design team
Techniciens et équipe de design qualifiés

- Cut-to-size specialists
Spécialistes en travail sur mesure

- CNC machinery
Machines CNC

- CAD/CAM facilities
Téchnologie de coupe CAD/CAM

- 4000 sqm of covered area
4000 m2 de surface couverte

- Exclusive partnerships with main quarries
Partenariats exclusifs avec les carrières



Improving stone



Residential building, France (2013).
Stone: Semi-Rijo LR honed
and Amarelo LR honed.

*Édifice résidentiel, France (2013).
Pierre: Semi-Rijo LR adouci
et Amarelo LR adouci.*





Improving stone



Public building, France (2011). Stone: Semi-Rijo LR honed.

Hôtel de ville et salle de spectacle, France (2011). Pierre: Semi-Rijo LR adouci.



Hotel B&B, Reims, France (2012). Stone: Semi-Rijo LR honed.
Hotel B&B, Reims, France (2012). Pierre: Semi-Rijo LR adouci.



Improving stone



Façade cut to size, France (2012). Stone: Semi-Rijo LR honed and Moleanos LR sandblasted.
Façade sur mesure, France (2012). Pierre: Semi-Rijo LR adouci et Moleanos LR sablé.



Façade St Savin, France (2013). Stone: Semi-Rijo LR honed.

Façade St Savin, France (2013). Pierre: Semi-Rijo LR adouci.



Groupama building, France (2010). Stone: Semi-Rijo LR and Valverde honed.
Édifice Groupama, France (2010). Pierre: Semi-Rijo LR et Valverde adouci.



Improving stone



Façade cut to size (different thicknesses), France (2014).

Stone: Blue Sky brushed and flamed.

Façade sur mesure (différents épaisseurs), France (2014).

Pierre: Blue Sky brossé et flammé.



Ministry of Energy, Alger, Algeria (2005).

Stone: Moca Creme honed.

Ministère de l'Énergie, Alger, Algérie (2005).

Pierre: Moca Creme adouci.

Royal Hotel Oran, Algeria (2004).

Stone: Moca Creme honed (interior and exterior).

Hôtel Royal Oran, Algérie (2004).

Pierre: Moca Creme adouci (intérieur et extérieur).





Improving stone

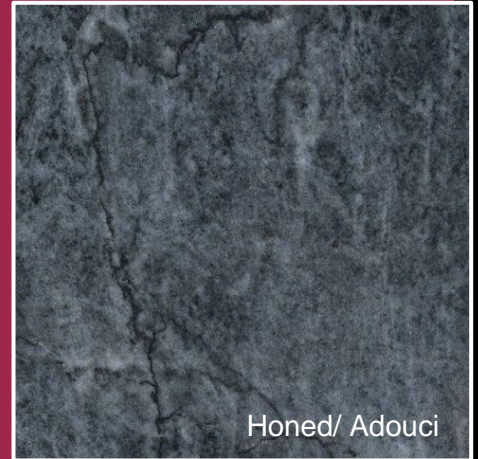
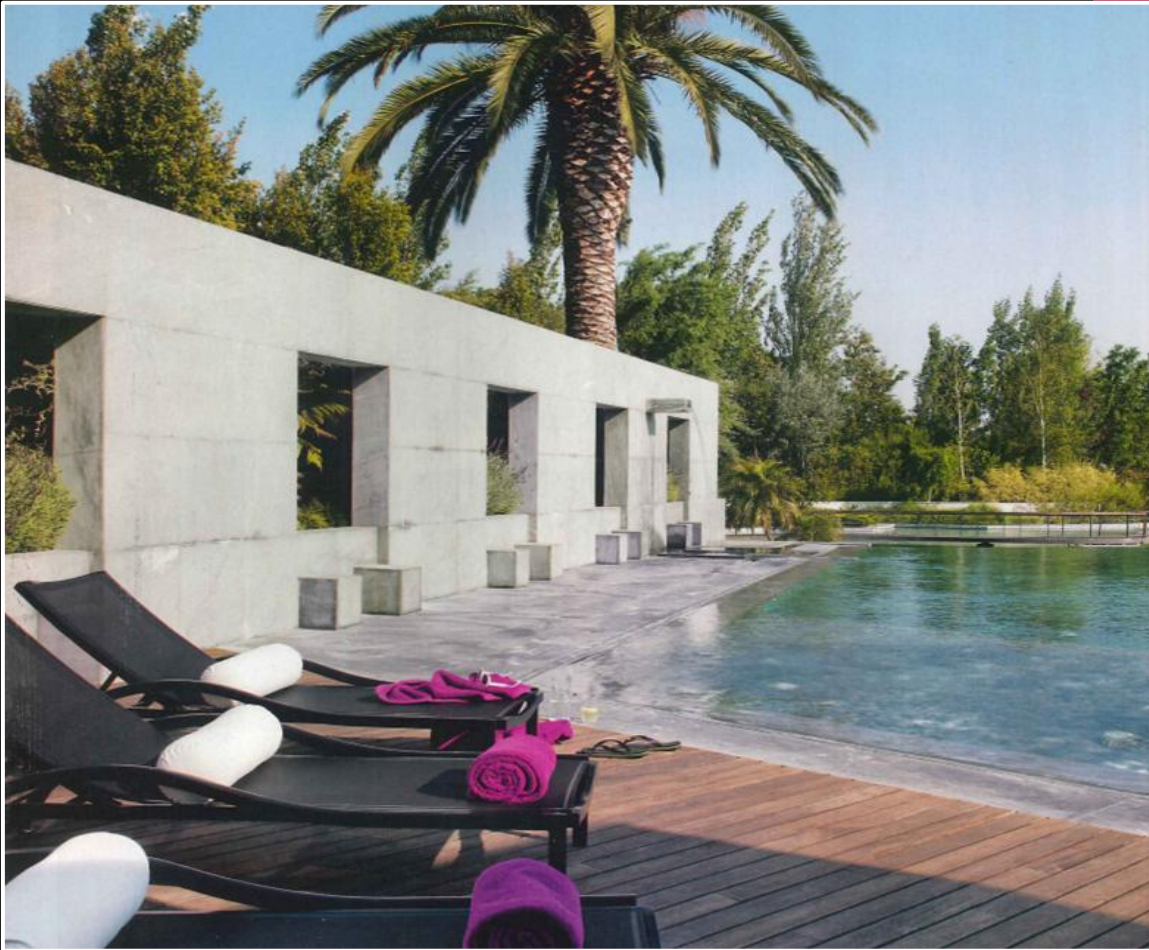

Honed/ Adouci



Sandblasted/ Sablé

Swimming pool, flooring, wall cladding, Portugal (2011). Stone: Ruivina sandblasted.
Piscine, revêtement de sols et murs, Portugal (2011). Pierre: Ruivina sablé.



Fenwicks, New Bond Street, London, U.K. (2010). Stone: Moleanos Blue polished (wall cladding) and Moleanos LR honed (wall cladding, flooring and reception desk).

Fenwicks, New Bond Street, London, R.U. (2010). Pierre: Moleanos Bleu poli (murs) et Moleanos LR adouci (murs, sols et comptoir de réception).



Improving stone



New Bond Street, London, UK (2010).
Stone: Moleanos LR honed (stairs, flooring),
Moleanos Blue polished (wall).

*New Bond Street, London, R.U. (2010).
Pierre: Moleanos LR adouci (escaliers, sols),
Moleanos Bleu poli (murs).*

Private residence, Portugal (2006).
Stone: Creme Marfil honed.
*Residence privée, Portugal (2006).
Pierre: Creme Marfil adouci.*

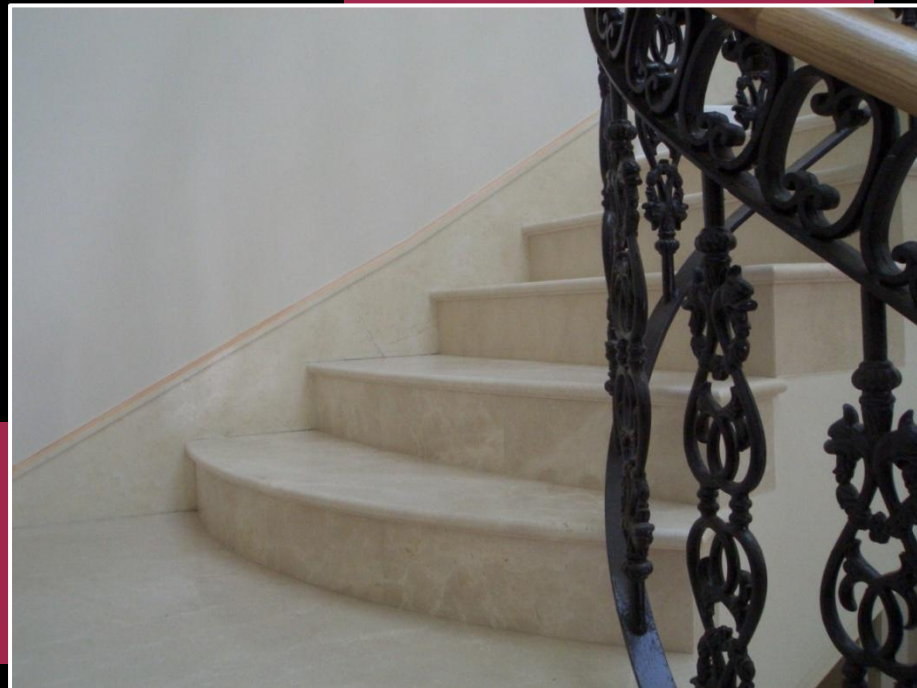



Office building, Rio de Janeiro, Brazil (2014). Stone: Moca Creme polished.

Édifice de bureaux, Rio de Janeiro, Brésil (2014). Pierre: Moca Creme poli.



Improving stone



Bathroom, Germany (2013).
Stone: Dark Emperador polished.
Salle de bain, Allemagne (2013).
Pierre: Dark Emperador poli.



Bathroom, Jersey (2012).
Stone: Moleanos LR honed.
Salle de bain, Jersey (2012).
Pierre: Moleanos LR adouci.



Improving stone



Bathroom, Barbados (2012).

Stone: Moca Creme honed.

Salle de bain, Barbados (2012).

Pierre: Moca Creme adouci.

Main room, UK (2013).

Stone: Moca Cream honed
and Black Zimbabwe polished.

Salle de séjour, R.U. (2013).

*Pierre: Moca Crème adouci
et Noir Zimbabwe poli.*



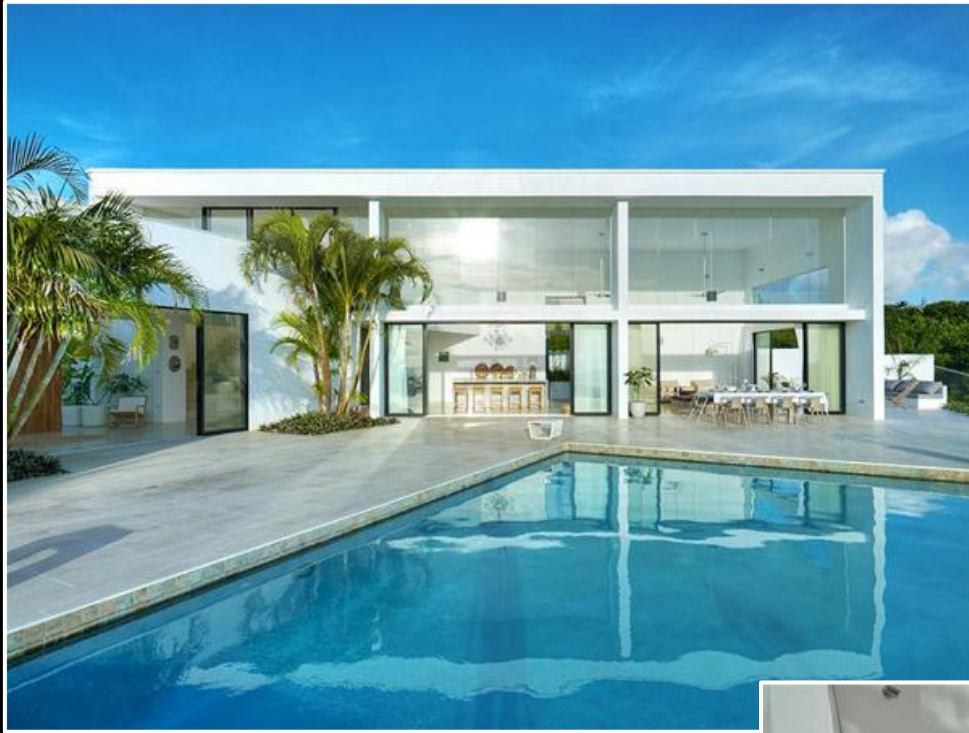

Luxury villa, Barbados (2012).
Stone: Moca Creme honed and sandblasted.
Villa de luxe, Barbados (2012).
Pierre: Moca Creme adouci et sablé.

Flooring: Moca Creme honed.
Kitchen top: Kashmir White polished.
Sols: Moca Creme adouci.
Plan de cuisine: Kashmir White poli.



Improving stone





Private residence, USA (2009). Stone: Moleanos LR honed.
Résidence privée, EUA (2009). Pierre: Moleanos LR adouci.



Private residence, USA (2009). Stone: Moleanos LR honed.
Résidence privée, EUA (2009). Pierre: Moleanos LR adouci.



Private residence, USA (2009). Stone: Moleanos LR honed (fireplace, flooring, columns).
Résidence privée, EUA (2009). Pierre: Moleanos LR adouci (cheminée, sols, colonnes).

 *Temptations Panels*



 **LUSO
ROCHAS**
Improving stone



Decorative wall panels in
Moleanos LR honed.

*Panneaux décoratifs en
Moleanos LR adouci.*

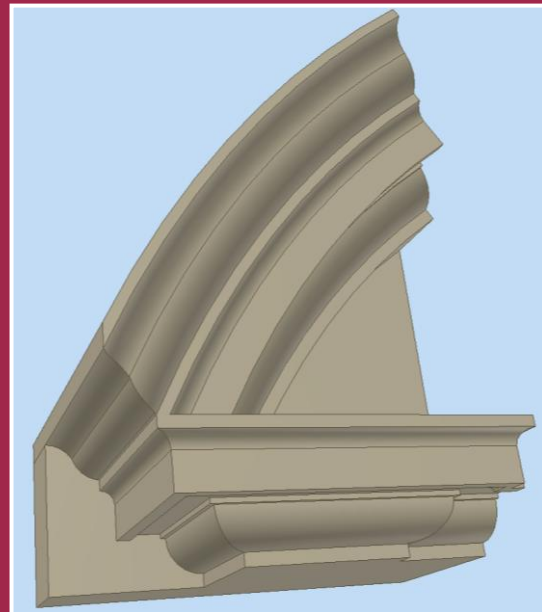
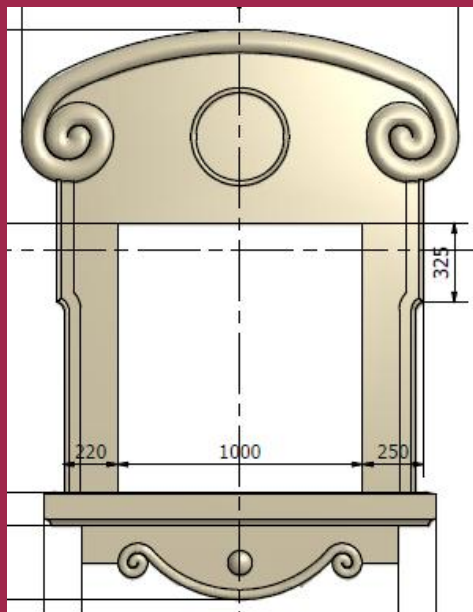

Limestone, a timeless choice

Pierre calcaire, un choix intemporel



SEMI-RIJO LR



MOLEANOS AZUL

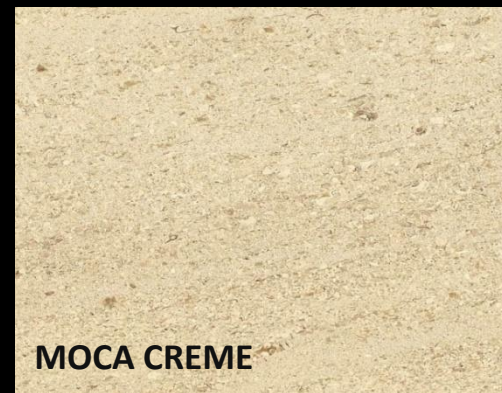

MOCA CREME



BLUE SKY



MOLEANOS RIJO



RUIVINA



Casal Silvérios – Pedra Furada
2715-358 Almargem do Bispo
PORTUGAL

P: (+351) 219677540 F: (+351) 219677549

E: contact@lusorochas.com

www.lusorochas.com



Facebook: Lusorochas Rochas Ornamentais Lda

Blog: lusorochas-limestone.blogspot.com

Twitter: @LusorochasLda

Pinterest: Lusorochas



Improving stone